

**QUARTZ CLOCK MOVEMENTS**

**TECHNICAL GUIDE**

**Requirements to make a CLOCK (using a QUARTZ MOVEMENT)**

- 1x Clock or Pendulum Movement
- 1x Clock face/body materials
- 1x Hour and minute hands + 1x Second hand
- 1x Numerals or dots or bars

**Optional/ideas:** Pendulum (to suit pendulum movement), hanger bracket, movement cover etc.

**Requirements to make a TURNED PEN (using PEN COMPONENTS)**

- 1x Set of Pen components
- 1x Mandrel (for turning the material on a lathe)
- 1x Material for the Pen's body (wood or acrylic)

**Optional / ideas:** 1x Pen holder & material to make a desk set. 1x Presentation pouch.



MOVEMENTS – MSSS, MSS, MS, ME, ML, MR (refer chart for Shaft lengths)



PENDULUM MOVEMENT – MP with Pendulum action (includes hanger bracket and Heavy duty battery)

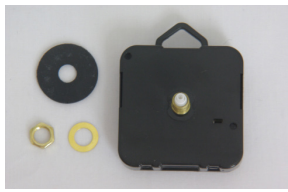

MOVEMENT – ME-HB (refer chart for Shaft length)

Each movement is supplied with a rubber washer, brass washer and a hexagon nut.  
 ALL other items (incl. hour & minute hands) are to be ordered separately.  
 NOTE: If the order does not specify a movement type, ME will be supplied.  
 All the movements use an AA battery.  
 (Battery not included – except MP)

**ALL MOVEMENTS ARE GUARANTEED FOR 5 YEARS**

*ML quartz movements are currently out of stock. Expected return May/June.*

**CLOCK MOVEMENTS**

*\*\* Prices are for the quantity of each particular type of movement- NOT the total quantity of movements.*

Code	Description	Threaded length (L)	Shaft length (H)	Max clock face thickness		Possible uses	Quantity ordered	Price**
				Hex nut (T)	Ext. nut (TE)			
MSSS	Very short shaft	5	13	3	—	CD, card, canvas		
MSS	Short shaft	7	15	5	6	Plywood, Perspex sheet	1 – 19	\$11.97
MS	Standard shaft	9	17	7	9	Thin board	20 – 49	\$11.12
ME	Extended shaft.	12.5	21	10	12	Paling, board, tile	50 – 99	\$10.26
ME-HB	ME w. moulded hanging bkt						100 & over	\$9.37
ML <sup>***</sup>	Long shaft ( <i>out of stock</i> )	15	22	13	15	Red gum		
MR	Reverse movement	13	19	10	12	Novelty <i>(i.e. where the clock is seen in a mirror)</i>	Each	\$6.69
MP	Pendulum movement	12.5	21	10	12	Imitation Grandfather clock, Box / case	1 – 4	\$14.98
	Includes a Heavy Duty battery. <i>Alkaline batteries are not recommended.</i>						5 – 9	\$14.63
							10 & over	\$14.31
PENDOP	Pendulum operator	The Pendulum operator converts any of the clock movements to a pendulum movement. Used when the MP's movement shaft is not a suitable length.				Any clock using a Pendulum	1 - 4	\$7.33
							5 - 9	\$7.06
							10 & over	\$6.75

**CLOCK ACCESSORIES**



**MOVEMENT COVER**  
Code: MOVCL  
Price ea: \$1.45

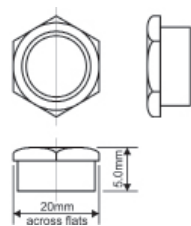

**EXTENSION NUT**  
Code: ENUT5  
Price ea.: \$0.48



**CD WASHER**  
Code: WASHCD  
Price ea. \$0.27

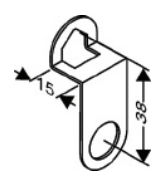

HANG-BKT-RS



HANG-BKT

**HANGER BRACKETS**  
Code: HANG-BKT-RS  
Suits ML, MS & MSS  
Code: HANG-BKT  
Suits ME, MSSS, MR  
Price each.: \$0.49

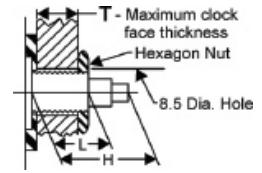

USING THE SUPPLIED HEXAGON NUT

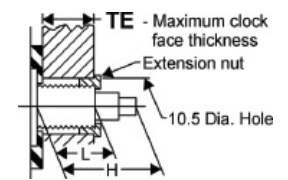

USE AN EXTENSION NUT for 2.0mm thicker material

**ALL PRICES INCLUDE GST**



















## HOUR & MINUTE AND SECOND HANDS

Quantity:	1 - 19 sets	20 - 49 sets	50 - 99 set	100 + sets	Additional Second Hand
Price	\$2.05 set	\$1.84 set	\$1.67 set	\$1.44 set	\$0.75

Prices are for the quantity of each particular set of hour, minute & second hands - NOT the total quantity of hands purchased.  
**Second hands are included in the price of the hour & minute hands. Additional second hands can be purchased separately.**

Colour codes: **B: BLACK** **G: GOLD** **R: RED** (second hands only) Please note Hands are not to scale.

Dimensions shown (mm) indicate the length of the hands, from the centre of the holes. If the hands are too long, they can be trimmed with scissors. The hands have a protective film which should be peeled off. NOTE 1: If the order for hands does not specify an item number, H2140 will be supplied; if no colour is specified Black will be supplied (i.e. H2140B).

 <p><b>Code: H211</b>            Hr. hand (mm): 72            Min. hand (mm): 102            Colour: B,G            Sec. Hand: 102</p>	 <p><b>Code: H219</b>            Hr. hand (mm): 60            Min. hand (mm): 90            Colour: B,G            Sec. Hand: 90"</p>	 <p><b>Code: H227</b>            Hr. hand (mm): 32            Min. hand (mm): 46            Colour: B,G            Sec. Hand: 57"</p>	 <p><b>Code: H231</b>            Hr. hand (mm): 50            Min. hand (mm): 72            Colour: B,G            Sec. Hand: 72</p>	 <p><b>Code: H233</b>            Hr. hand (mm): 65            Min. hand (mm): 100            Colour: B,G            Sec. Hand: 102</p>	 <p><b>Code: H240</b>            Hr. hand (mm): 72            Min. hand (mm): 102            Colour: B,G            Sec. Hand: 102</p>														
 <p><b>Code: H241</b>            Hr. hand (mm): 55            Min. hand (mm): 79            Colour: B,G            Sec. Hand: 72</p>	 <p><b>Code: H257</b>            Hr. hand (mm): 39            Min. hand (mm): 50            Colour: B,G            Sec. Hand: 57"</p>	 <p><b>Code: H270</b>            Hr. hand (mm): 91            Min. hand (mm): 127            Colour: B,G            Sec. Hand: 102</p>	 <p><b>Code: H277</b>            Hr. hand (mm): 44            Min. hand (mm): 63            Colour: B,G            Sec. Hand: 72</p>	 <p><b>Code: H2140****</b>            Hr. hand (mm): 62            Min. hand (mm): 95            Colour: B,G            Sec. Hand: 102</p>	 <p><b>Code: H2212</b>            Hr. hand (mm): 32            Min. hand (mm): 45            Colour: B,G            Sec. Hand: 57"</p>														
 <p><b>Code: H2282</b>            Hr. hand (mm): 38            Min. hand (mm): 53            Colour: B,G            Sec. Hand: 57"</p>	 <p><b>Code: H2291</b>            Hr. hand (mm): 45            Min. hand (mm): 62            Colour: B,G            Sec. Hand: 72</p>	 <p><b>Code: H2351</b>            Hr. hand (mm): 31            Min. hand (mm): 40            Colour: B            Sec. Hand: 40</p>	 <p><b>Code: H2361</b>            Hr. hand (mm): 25            Min. hand (mm): 34            Colour: B,G            Sec. Hand: 37</p>	 <p><b>Code: H2382</b>            Hr. hand (mm): 21            Min. hand (mm): 30            Colour: B,G            Sec. Hand: 37</p>	 <p><b>Second Hands</b></p> <table style="width: 100%; border-collapse: collapse;"> <thead> <tr> <th style="text-align: left;">Colour</th> <th style="text-align: left;">Code/Length</th> </tr> </thead> <tbody> <tr> <td>R</td> <td>SH37R / 37mm</td> </tr> <tr> <td>R</td> <td>SH40R / 40mm</td> </tr> <tr> <td>R</td> <td>SH72R / 72mm</td> </tr> <tr> <td>R</td> <td>SH102R / 102mm</td> </tr> <tr> <td>R,B,G</td> <td>SH90R/B/G / 90mm</td> </tr> <tr> <td>R,B,G</td> <td>SH57R/B/G / 57mm</td> </tr> </tbody> </table>	Colour	Code/Length	R	SH37R / 37mm	R	SH40R / 40mm	R	SH72R / 72mm	R	SH102R / 102mm	R,B,G	SH90R/B/G / 90mm	R,B,G	SH57R/B/G / 57mm
Colour	Code/Length																		
R	SH37R / 37mm																		
R	SH40R / 40mm																		
R	SH72R / 72mm																		
R	SH102R / 102mm																		
R,B,G	SH90R/B/G / 90mm																		
R,B,G	SH57R/B/G / 57mm																		

**NOTE:** Items may vary slightly from photo shown.

\*\* Choice of red, black or gold second hands (please specify colour - if not specified, red second hands will be supplied).

\*\*\*\* H2142B/G have been replaced by H2140B/G. H2140 has shorter hour & minute hands than H2142

**NOTE:** H211G, H219B, H219G H270B & H277G, are currently out of stock. More stock expected April, 2024.

# 2024 CLOCK & PEN CATALOGUE

## PENDULUMS

Quantity:	PENDUA	PENDUB
1 - 4	\$6.21 ea	\$12.68 ea
5 - 9	\$6.02 ea	\$12.21 ea
10 & over	\$5.84 ea	\$11.72 ea

To shorten the pendulum: remove the bob, cut the shaft and re-assemble



**PENDULUM A**  
Code: PENDUA

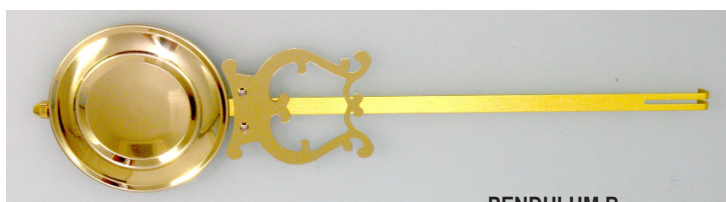

**PENDULUM B**  
Code: PENDUB

## PENDULUMS RODS

Pendulum Rod Size	Code	Price
170mm long	PENDUR	\$3.91 ea
270mm long	PENDURL	\$4.83 ea



Please note: Photos are not to scale.

## RESIN ART CLOCK PROJECT



The **RESIN ART CLOCK** is a **Materials & Technologies Specializations focused project** which allows students to create a personalized clock face using coloured Epoxy Resin. Student's can mix, pour and manipulate the resin into the desired patterns to create a unique clock face, of their own

design. This Clock making project is suitable for students in years 8 to 12 in a supervised environment.

- More information is available in the Overview and Teaching unit



**For 10 Students:**

**Code: RESART10 – \$290.00**

This kit contains enough 25cm clock faces, movements, hands, hangers and numerals for 10 clocks. It includes 1.0L of resin and 6 x 10g colour packs.

The colours are: Dark Blue; Light Blue; White; Black; Gold; Green

## CLOCK NUMERALS

Quantity:	NUMA / NUMR	NUMD / NUMB
1 - 19	\$3.68 set	\$2.58 set
20 - 49	\$3.55 set	\$2.45 set
50 - 99	\$3.43 set	\$2.30 set
100 & over	\$3.28 set	\$2.18 set

Finish: Gold or Black (in all sizes and styles)

When ordering, state TYPE, FINISH and SIZE - If not specified, NUMA-15mm Black will be supplied. "Numeral Positioning Guide" available. *Please enquire.*

These are moulded plastic numerals, approx. 1 - 1 ½ mm thick with self-adhesive and a backing sheet. If required, apply a commercially available adhesive.

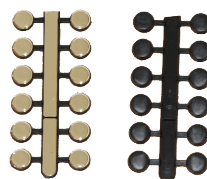

**NUMD (Set of 12 dots)**  
Size 4.5, 8 & 10 mm

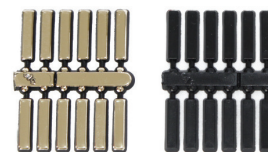

**NUMB (Set of 12 bars)**  
Size 10, 12 & 19 mm



**NUMA (Arabic set of 12)**  
Size 10, 12, 15, 20, 25 mm



**NUMR (Roman set of 12)**  
Size 10, 12, 15, 20, 25 mm

## CLOCK FACE

Code: CLPLYF - \$5.56

Round Clock Face – a 25cm Diameter Clock face with a hole in the middle (to suit our movements).

Made from 3mm thick Plywood and ready to paint.



## RESIN ART CLOCK KIT

Code: RESARTSING (MICAXXXX)– \$38.50

The RESIN ART CLOCK allows you to create a personalized clock face using coloured Epoxy Resin. This kit includes one clock kit, 25cm clock face, 100ml Epoxy resin, disposable gloves, stirrers and a choice from 5 different resin colour palletes.

Palletes to choose from (pick one):

1. MICAOCLEAN (Blue) = Navy Blue / Teal Blue / White
2. MICAGREEN (Green) = Aqua Green / Gold / Teal Blue
3. MICAPURPLE (Peacock) = Purple / Pink / Aqua Green
4. MICABLACK (Red) = Black / Gold / Red Wine
5. MICAPASTEL (Pastel) = Baby Pink / Lilac / Baby Blue

**For 20 Students:**

**Code: RESART20 – \$560.00**

This kit contains enough 25cm clock faces, movements, hands, hangers and numerals for 20 clocks. It includes 2.0L of resin and 8x 10g colour packs.

The colours are: Dark Blue; Light Blue; White; Black; Gold; Purple; Green; Red

## HOW IT GOES TOGETHER

### QUARTZ CLOCK MOVEMENT

This is a 56mm square AA battery operated movement, and is inserted from the back of the clock's face, with the hands and numerals being put on once the movement is mounted.

**NOTE:** More Clock design information is in our Clock Teaching unit, which is supplied with every Clock order.

- We can also provide a Numeral Positioning Guide.

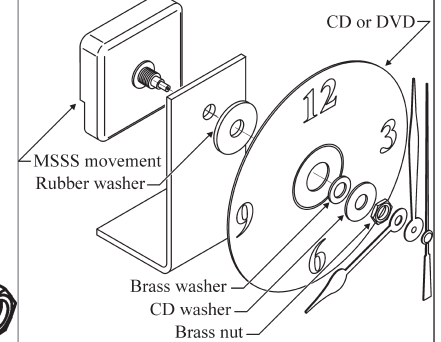
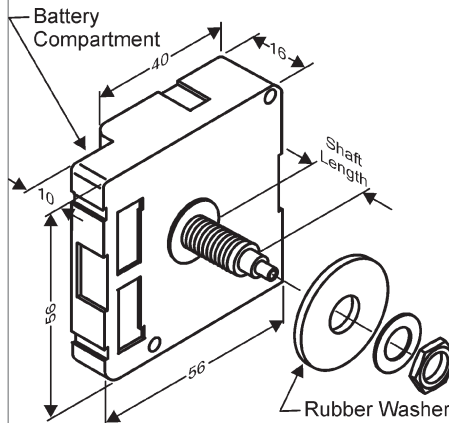

### THE PENDULUM MOVEMENT

The quartz Pendulum movement incorporates both the movement and pendulum in one unit.

### THE PENDULUM OPERATOR

A Pendulum Operator is designed so that it can be used with any of the movements, to take advantage of different shaft lengths. The selected movement is assembled into the operator (remember to allow for the thickness of the pendulum operator's case, as this reduces the usable shaft length by approximately 1mm).

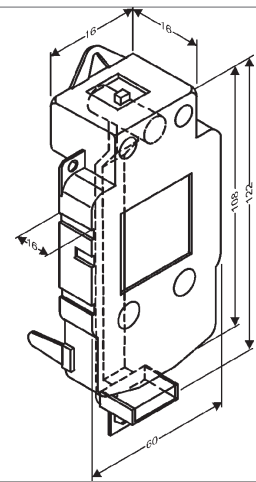
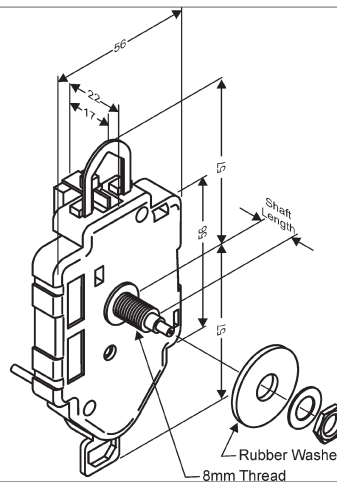

## CLOCK NUMERALS (LIMITED QUANTITIES)

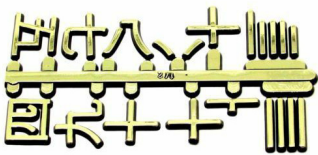

### CHINESE CHARACTERS

Code: NUMC

Set of 12 Chinese Characters.  
Gold.

Size 12 & 20 mm.  
\$3.33 (1 - 19 sets)  
\$3.19 (20 - 49 sets)  
\$3.07 (50 - 99 sets)  
\$2.94 (100+ sets)



### HEBREW

Code: NUMH

Set of 12 Hebrew characters.  
Gold.

Size 20 mm (approx.)  
\$3.33 (1 - 19 sets)  
\$3.19 (20 - 49 sets)  
\$3.07 (50 - 99 sets)  
\$2.94 (100+ sets)



### PARTIAL SUNBURSTS – ARABIC

Code: NUMSUNA

Set of Part Sunbursts – Arabic  
Numerals

Gold.  
Size 75, 100 & 125 mm  
\$3.64 (75mm)  
\$4.16 (100mm)  
\$4.68 (125mm)



### PARTIAL SUNBURSTS – OLD ENGLISH

Code: NUMSUNOE

Gold.

Size 75, 100, 125 mm  
\$3.50 (75mm)  
\$4.00 (100mm)  
\$4.50 (125mm)

Please contact us to confirm quantities available before ordering.

# 2024 CLOCK & PEN CATALOGUE

## INSERT CLOCKS

Code	Bezel dia.	Bezel colour.	Face colour	Price**				Battery type	Battery	Approx hole size
				1-4	5-9	10-19	20 +			
ICS36	36	Gold	White	\$16.16	\$15.20	\$14.24	\$13.29	Button cell	Included	33mm dia
ICS36GG	36	Gold	Gold					Button cell	Included	33mm dia
ICS38GW	38	Gold	White	\$16.16	\$15.20	\$14.24	\$13.29	Button cell	Included	36mm dia
ICM56	56	Gold	White	\$15.68	\$15.00	\$14.27	\$13.54	'N' type	Not included	52mm dia
ICM56GG	56	Gold	Gold	\$15.68	\$15.00	\$14.27	\$13.54	'N' type	Not included	52mm dia
ICMT63	63	Gold	White	\$13.78				'N' type	Not included	58mm dia
ICLC80	80	Chrome	White	\$17.86				AA	Not included	76mm dia
ICLG80	80	Gold	White	\$17.86				AA	Not included	76mm dia
ICLLC130	130	Chrome	White	\$26.96				AA	Not included	82mm dia
ICLLG130	130	Gold	Gold	\$26.96				AA	Not included	82mm dia

**Please note:**

Insert Clocks are not to scale.

Insert clocks are complete clocks – movement, hands, dial face with Roman numerals and front glass with bezel.

For these clocks you need to make a suitable clock housing which allows the clock to be inserted from the front.

Further technical details available in the Product Catalogue.



Code: ICS36



Code: ICS36GG



Code: ICS38GW



Code: ICM56



Code: ICM56GG



Code: ICMT63



Code: ICLC80



Code: ICLG80



Code: ICLLC130



Code: ICLLG130

\*\* Prices are for the quantity of each particular type of insert clock- NOT the total quantity of insert clocks.

### INSERT CLOCK

An Insert Clock (sometimes called a “fit up clock”) is a complete clock, but without a body. It consists of the movement, clock face, hands, glass and bezel (surround or outside ring). They range in size from a bezel diameter of 36mm to 130mm.

An insert clock is fitted from the front of the clock, into an appropriate size hole in the clock’s body.

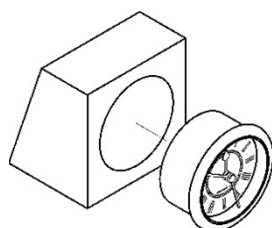

The advantages of using insert clocks include:

- The attractive finished appearance of the clock
- The smaller inserts can be used in places where the quartz movement won't fit

### INSERT CLOCK DIMENSIONS

**A** – The overall diameter of the outside of the clock insert (the bezel).

**B** – the inserts' mounting diameter. This dimension shows the diameter of the counter-bore that the insert will fit into.

**C** – the mounting depth. This dimension is measured from the back of the bezel to the back of the insert's housing. This is how deep a counter-bored insert mount hole should be.

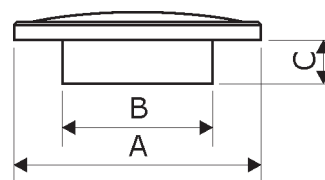

## PRIMARY LEVEL CLOCK MAKING

The making of clocks in the classroom is very versatile. It provides a lot of scope, as it can be used in almost all subjects and tailored to most age and skill levels. Scorpio Technology stocks a wide selection of Hour & Minute Hands, Second Hands, Clock Numerals and Hanger Brackets, allowing students to make simple clock faces using their own art work (e.g. using CDs or even old traditional vinyl records as the clock face base). For more advanced clocks, students can use quartz clock movements. A choice of different shaft lengths is available.

(See "Clock Components" for more details).

Clock making develops the students' imagination, research, design, planning and manufacturing skills, incorporating a variety of materials. Students can develop their own design or follow the teachers' guidelines. An added bonus is that it is a cost-effective unit of work which provides a useable end product.

### CD CLOCK

Code: CDCLOCK

- Design & make your own working clock using readily available items such as CDs (not supplied), a student's own art work on cardboard backing, etc.
  - This kit is supplied with a MSSS Quartz Clock Movement, Hanger Bracket, CD Washer, Second Hand and a choice of Hour & Minute hands (as specified)
  - Please specify choice of Hour/Minute hands from **270 Black (CDCLOCK27B)** or **Gold (CDCLOCK27G)** or **2212 Black (CDCLOCK22B)** or **Gold (CDCLOCK22G)**
  - The 2212 can be trimmed down to the desired length
  - Clock numerals can be purchased separately to finish off your **CD CLOCK**
  - Suitable Ages 10+.
- \$11.96 each (1 - 49 sets)  
\$11.01 each (50+ sets)



### LPCLOCK

Code: LPCLOCK

- Design & make your own working clock using readily available items such as old vinyl LPs, a student's own art work on cardboard backing, etc.
  - This kit is supplied with a MSSS Quartz Clock Movement, Hanger Bracket, Second Hand and a choice of Hour & Minute hands (as specified below)
  - Please specify choice of Hour/Minute hands from **270 Black (LPCLOCK27B)** or **Gold (LPCLOCK27G)** (**NOTE: The centre hole of the vinyl LP needs to be enlarged slightly to fit the Movement shaft**).
  - Clock numerals can be purchased separately to finish off your **LP CLOCK**
  - Suitable Ages 10+.
- \$11.96 each (1 - 49 sets)  
\$11.01 each (50+ sets)

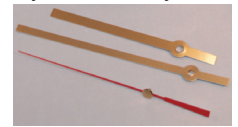

### MAKE YOUR OWN CLOCK KIT

Code: KJ8996

- This educational clock is designed to stimulate a child's curiosity about the concept of time
  - Easy to assemble with little or no adult assistance. Includes wind-up pendulum based mechanism
  - No batteries required
  - 195mm (dia.)
  - Ages 6+.
- \$21.95



### LEMON CLOCK

Code: FSG3306

- Simply add your own lemon to turn this kit into an amazing lemon-powered clock
  - Discover the science of batteries (it has none)
  - Only uses the chemical power of the lemon
- \$10.30



## POSTAGE RATES

Weight	Under 0.5 kg	0.5 - 2.0 kg	2 - 5 kg	5 - 10 kg	10 - 25 kg	Over 25 kg
Victoria	\$11.40	\$14.76	\$16.75	\$20.13	\$26.85	Please enquire
NSW / SA / TAS	\$11.40	\$19.13	\$21.47	\$24.15	\$33.56	
Brisbane, Perth	\$11.40	\$21.47	\$24.15	\$30.19	\$40.24	
QLD / WA / NT (Rural)	\$11.40	\$23.48	\$26.85	\$33.56	\$46.96	

- ✓ E-mail, post or fax your official school order to us, including the teacher's name to speed delivery.
- ✓ An invoice will be included with the goods. Note: you do not need to open an account with us.
- ✓ Orders are dispatched quickly and are sent using Australia Post.
- ✓ Prices and stock availability are subject to change without notice.
- ✓ Payment is by cheque, EFT or credit card. Please note there will be a 1.5% surcharge on all credit card payments over \$250.

## PEN COMPONENTS

Code: PNCOMP

Quantity:	Price per pack of 5
1 - 4 packs	\$21.29
5 - 9 packs	\$19.57
10 - 19 packs	\$17.86
20 + packs	\$17.04

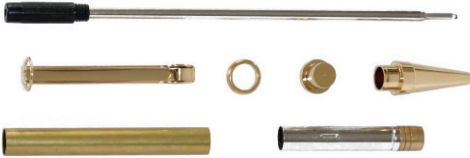

SPARE PARTS AVAILABLE

**PEN REFILLS**  
replacement  
refills for the turned pens  
Red Pen refill

Code: PENREFR - \$0.68 each

## ACCESSORIES FOR USE WITH TURNED PENS



**MANDREL for turning a pen**  
(from wood or other materials)  
Code: MANDREL - \$30.99 each

This mandrel is required for turning the pen material pieces in a lathe when our sets of Pen components are used.



**ACRYLIC PEN BLANKS**  
for turning to make a pen's body  
Code: PENBLANK - \$4.54 each

This Acrylic pen blank can be turned on a lathe in a similar fashion to timber. Gives the choice of a different looking pen - this is a grey / purple swirling patterned blank.

Size: diameter 19mm x 127 mm long



**PEN POUCHES**  
for turning a pen into a gift!  
Code: POUCH - \$1.04 each

These pouches are of black velour with a closing drawstring at the end.



**Australia themed PEN CLIP**  
Code: PENCLIPAUS - \$0.66

This clip is for use with the pen components in place of the supplied clip. Great for turning the pen into a present for overseas visitors.

## PEN HOLDERS

Q'TY of packs	PNHB / PNHG
1 - 4 packs	\$9.20 per pack
5 - 9 packs	\$8.77 per pack
10 + packs	\$8.47 per pack

Sold in packs of 5



**PEN HOLDER with Gold base**

PNHB with BLACK trumpet PNHG with GOLD trumpet

PEN HOLDERS are supplied with 12mm long screws (included in the price).

## PEN HOLDER SCREWS

CODE	LENGTH (mm)	PRICE
SCRPH15	15mm	\$0.47
SCRPH18	18mm	\$0.47

Sold in packs of 5

For thicker materials longer screws are also available.

## WOODWORKING HARDWARE



Code: HANDLE - \$6.02 for pack of 10

U-shaped pull handle. Mild steel. 64mm(w) with two 3.5mm screw holes (Screws not included).

We stock a wide variety of screws. Please check our online Products Catalogue.

## BATTERIES

Code	Battery size	Type	QTY	Price per pack
BATTAA	AA	Toshiba, Heavy Duty	4	\$3.90
BATTN	N Type	Super Heavy Duty	2	\$2.27

## TEACHING AIDS & PUBLICATIONS

CODE: BOOKWOODCL - \$50.59

"The Complete Guide to Making Wooden Clocks" - John A. Nelson. This book shows how to make beautiful timber clocks. Each clock has been photographed in colour, has instructions and plans. Suitable for a range of skill levels.

CODE: BOOKPENTURN - \$44.26

"The Pen Turner's Workbook: Making Pens from Simple to Stunning" - Barry Gross. This stunning book shows a large variety of techniques and ideas to make beautiful lathe turned pens. The book is full of close-up photos showing step by step instructions. An excellent resource.

We also have catalogues for **Technology, Solar Kits, Components, Physics & Labware**, which can be downloaded from our website.

We are progressively adding more items to our online catalogues and information. Please have a look - we would appreciate feedback on what else you would like to see. Thank you for your continuing support.

ALL PRICES  
INCLUDE GST

SCORPIO TECHNOLOGY VIC PTY. LTD.

March 2024v1 • www.scorpiotechnology.com.au • sales@scorpiotechnology.com.au • ABN 34 056 661 422



# CLOCK ORDER FORM

## CUSTOMER DETAILS

Purchase Order No. \_\_\_\_\_

Name / Teacher \_\_\_\_\_

School Name \_\_\_\_\_

Street Address \_\_\_\_\_

Suburb \_\_\_\_\_ State \_\_\_\_\_ Postcode \_\_\_\_\_

Teacher's Email \_\_\_\_\_ Tel: \_\_\_\_\_

QTY	CLOCK MOVEMENT
	<b>MSSS</b> – Very short shaft
	<b>MSS</b> – Short shaft
	<b>MS</b> – Standard shaft
	<b>ME</b> – Extended shaft
	<b>ME-HB</b> – ME with hanging bracket
	<b>ML</b> – Long shaft
	<b>MR</b> – Reverse Movement
	<b>MP</b> – Pendulum Movement
	<b>PENDOP</b> – Pendulum Operator

QTY	SECOND HANDS	RED	BLACK	GOLD
	<b>SH102</b> – 102mm		N/A	N/A
	<b>SH90</b> – 90mm			
	<b>SH72</b> – 72mm		N/A	N/A
	<b>SH57</b> – 57mm			
	<b>SH40</b> – 40mm		N/A	N/A
	<b>SH32</b> – 32mm		N/A	N/A

QTY	HANGER BRACKET
	<b>HANG-BKT</b>

QTY	HANGER BRACKET
	<b>HANG-BKT-RS</b>

QTY	CLOCK HANDS	BLACK	GOLD
	<b>H211</b> – 72mm x 102mm		
	<b>H219</b> – 60mm x 80mm		
	<b>H227</b> – 32mm x 48mm		
	<b>H231</b> – 50mm x 72mm		
	<b>H233</b> – 65mm x 100mm		
	<b>H240</b> – 72mm x 102mm		
	<b>H241</b> – 55mm x 78mm		
	<b>H257</b> – 39mm x 50mm		
	<b>H270</b> – 91mm x 127mm		

QTY	CLOCK HANDS	BLACK	GOLD
	<b>H277</b> – 44mm x 53mm		
	<b>H2142</b> – 80mm x 110mm		
	<b>H2212</b> – 32mm x 45mm		
	<b>H2282</b> – 38mm x 53mm		
	<b>H2291</b> – 45mm x 62mm		
	<b>H2351</b> – 31mm x 40mm		N/A
	<b>H2361</b> – 25mm x 34mm		
	<b>H2382</b> – 21mm x 30mm		



QTY	NUMERALS - Arabic	BLACK	GOLD
	NUMA10		
	NUMA12		
	NUMA15		
	NUMA20		
	NUMA25		

QTY	NUMERALS - Roman	BLACK	GOLD
	NUMR10		
	NUMR12		
	NUMR15		
	NUMR20		
	NUMR25		

QTY	NUMERALS - Dots	BLACK	GOLD
	NUMD4.5		
	NUMDB		
	NUMAD10		

QTY	NUMERALS - Bars	BLACK	GOLD
	NUMB10		
	NUMB12		
	NUMB19		

QTY	SUNBURSTS - Arabic	GOLD
	NUMSUNA - 75mm	
	NUMSUNA - 100mm	
	NUMSUNA - 125mm	
	NUMSUNA - 150mm	

QTY	SUNBURSTS - Old English	GOLD
	NUMSUNOE - 75mm	
	NUMSUNOE - 100mm	
	NUMSUNOE - 125mm	

QTY	INSERT CLOCKS	BEZEL	FACE
	ICS36	GOLD	WHITE
	ICS36GG	GOLD	GOLD
	ICS38GW	GOLD	WHITE
	ICM56	GOLD	WHITE
	ICM56GG	GOLD	GOLD

QTY	INSERT CLOCKS	BEZEL	FACE
	ICMT63	GOLD	WHITE
	ICLC80	CHROME	WHITE
	ICLG80	GOLD	WHITE
	ICLLC130	CHROME	WHITE
	ICLLG130	GOLD	GOLD

QTY	MISCELLANEOUS
	CD WASHER - CD Washer
	ENUT5 - Extension Nut 5mm
	MOVEMENT COVER
	PENDULUM A
	PENDULUM B

QTY	PENS
	PEN COMPONENTS
	PEN HOLDERS - Black or Gold
	PEN POUCHES

QTY	ADDITIONAL ITEMS